

SIDDHARTH®

Kerastone

Collection of

Matt

600X1200MM

overtime

COLOURS

STORY



It has survived not only five centuries, but also the leap into electronic typesetting, remaining essentially unchanged. It was popularised in the 1960s with the release of Letraset sheets.



TIME WHITE



TIME IVORY



TIME TAUPE



TIME GREY



TIME DARK

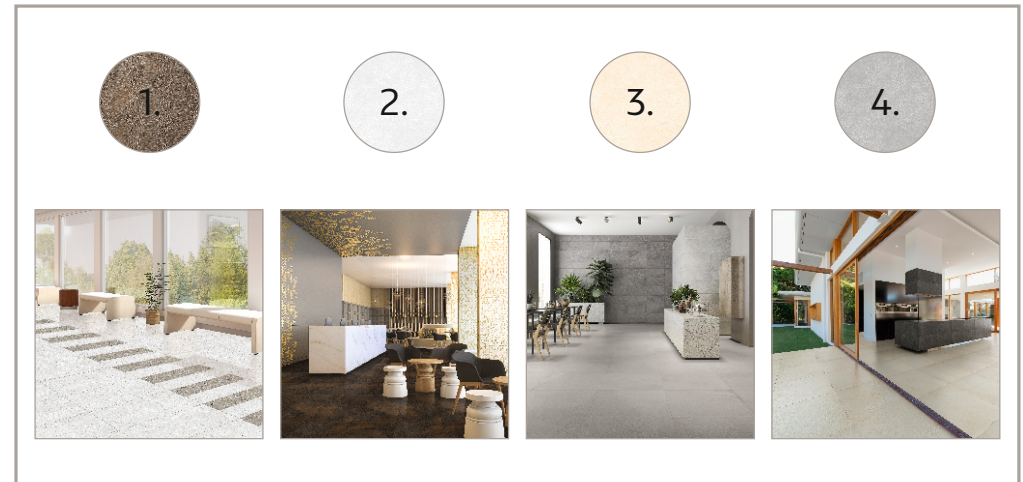

APPLICATION AREAS



KITCHEN



OUTDOOR



INTERIOR



OFFICES



COMMERCIAL



COLLAGES



GOVERNMENT



BANK

About US ...

Jalaram Ceramics .Ltd a leading manufacturer of Ceramic Wall & Floor, & Vitrified Floor Tiles in India, having successful track record of over Two Decades to its credit, Employing the latest International Technology & F Vehicles) of Italy offering World Class Ceramic, Vitrified Tiles of Unmatched Quality.



600X1200MM



*project
Needless to say, to deliver what we commit,
we use the best combination of high
quality, high grade raw material imported
from the best sources world over.*

Matt
Collection

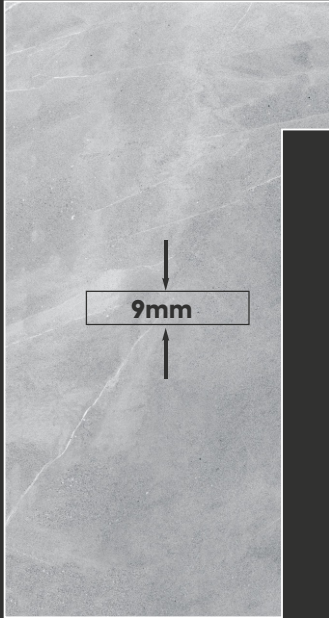

Lorem Ipsum is simply dummy text of the printing and typesetting since the 1500s, when an but also the desktop.

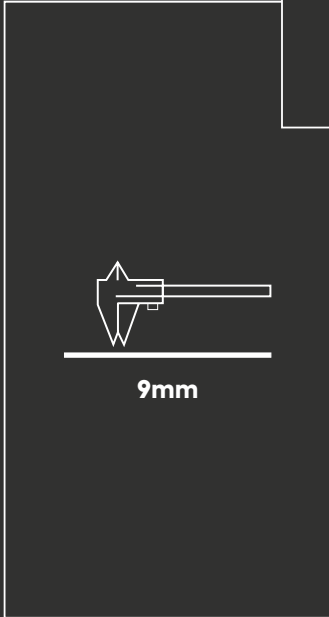

600X1200MM

Matt

Collection



ECO FRIENDLY
RESPECTUEUX DE
L'ENVIRONNEMENT
UMWELTFREUNDLICH



EASY HANDLING
MANIPULATION FACILE
UMWELTFREUNDLICH



REDUCTION OF CONSTRUCTION TIME
RÉDUCTION DU TEMPS DE
CONSTRUCTION
VERKÜRZUNG DER BAUZEIT



EASY DRILLING CUTTING
AND HANDLING
PERÇAGE, DÉCOUPE ET
MANIPULATION FACILES
EINFACHES BOHREN,
SCHNEIDEN UND HANDHABEN



REDUCTION OF TRANSPORT COSTS
LA RÉDUCTION DES COÛTS
DE TRANSPORT
REDUZIERUNG DER
TRANSPORTKOSTEN



60X 120CM

Lorem Ipsum is simply dummy text of the printing and typesetting since the 1500s, when an unknown printer took a galley of type and set it to type. It has survived not only five centuries, but also the transition to desktop publishing.

Matt
Collection



Armonia Aqua

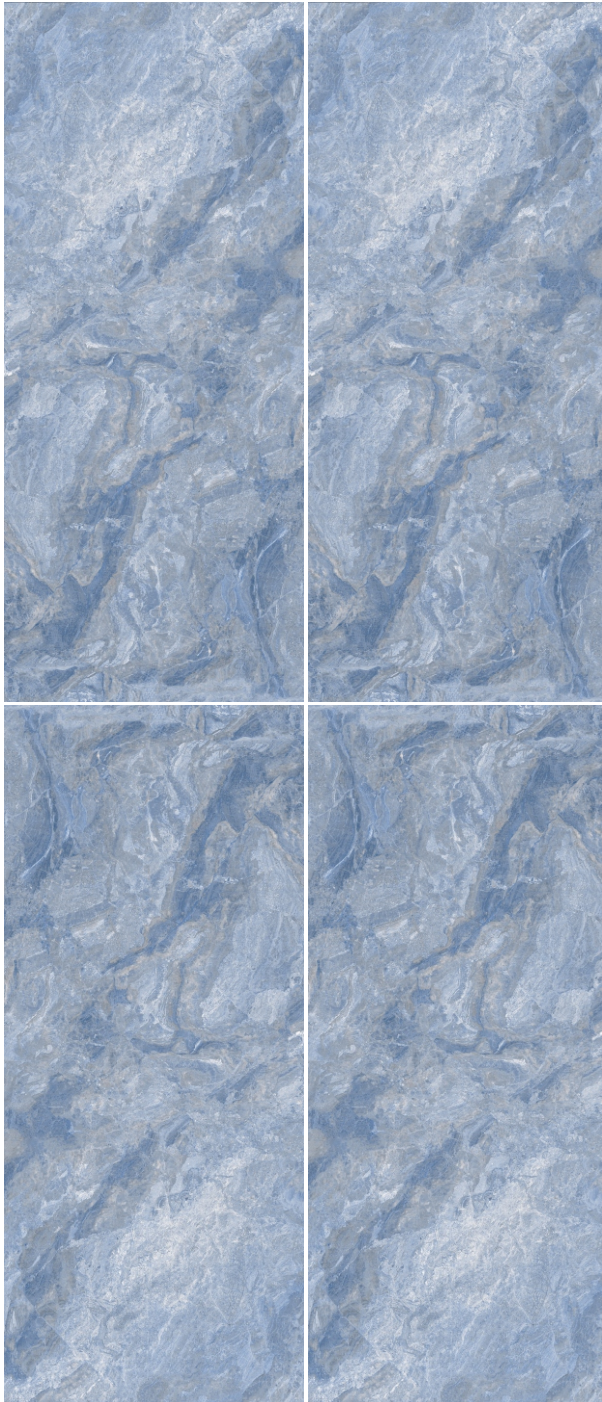

Random - 01
600x1200mm

Matt
Collection

Armonia White



Random - 01
600x1200mm

Matt
Collection

Armonia Mist



Random - 01
600x1200mm

Matt
Collection

Armonia Pearl



Random - 01
600x1200mm

Matt
Collection

Armonia Rust

Random - 03
600x1200mm

Matt
Collection



Barretos Blanco



Random - 01
600x1200mm

Matt
Collection

Barretos Steel



Random - 01
600x1200mm

Matt
Collection

Barretos Brown

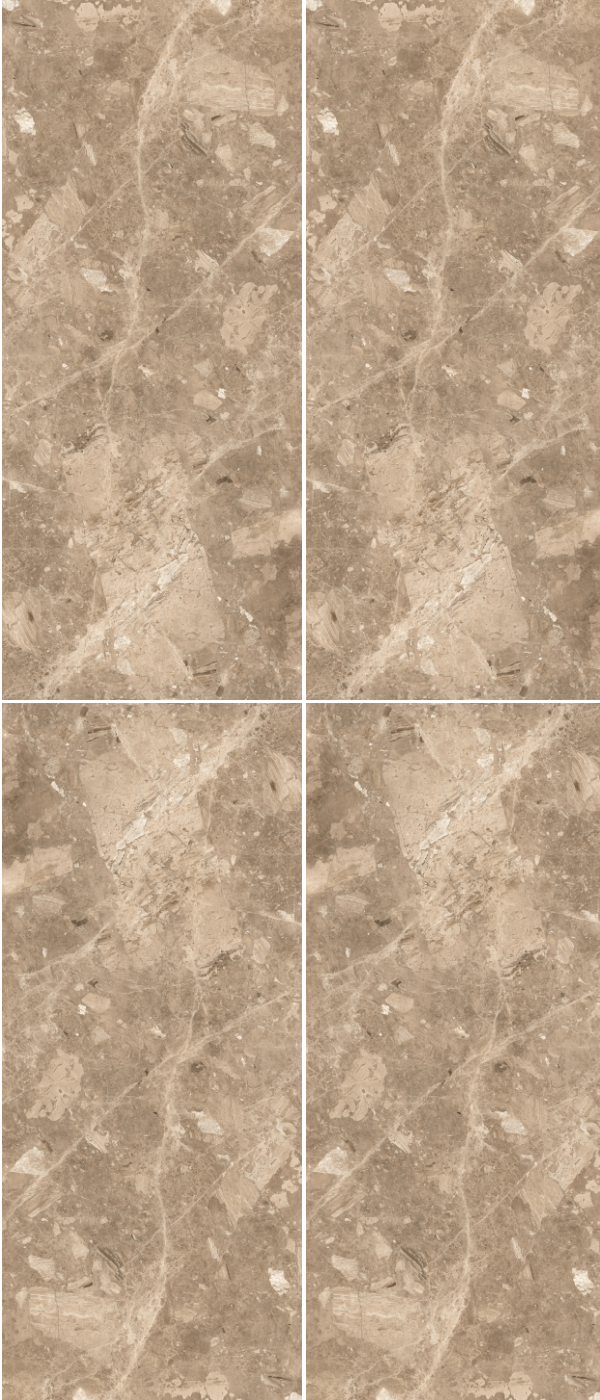

Random - 01
600x1200mm

Matt
Collection

Barretos Crema



Random - 01
600x1200mm

Matt
Collection

Barretos Pearl



Random - 01
600x1200mm

Matt
Collection

Belgrds White

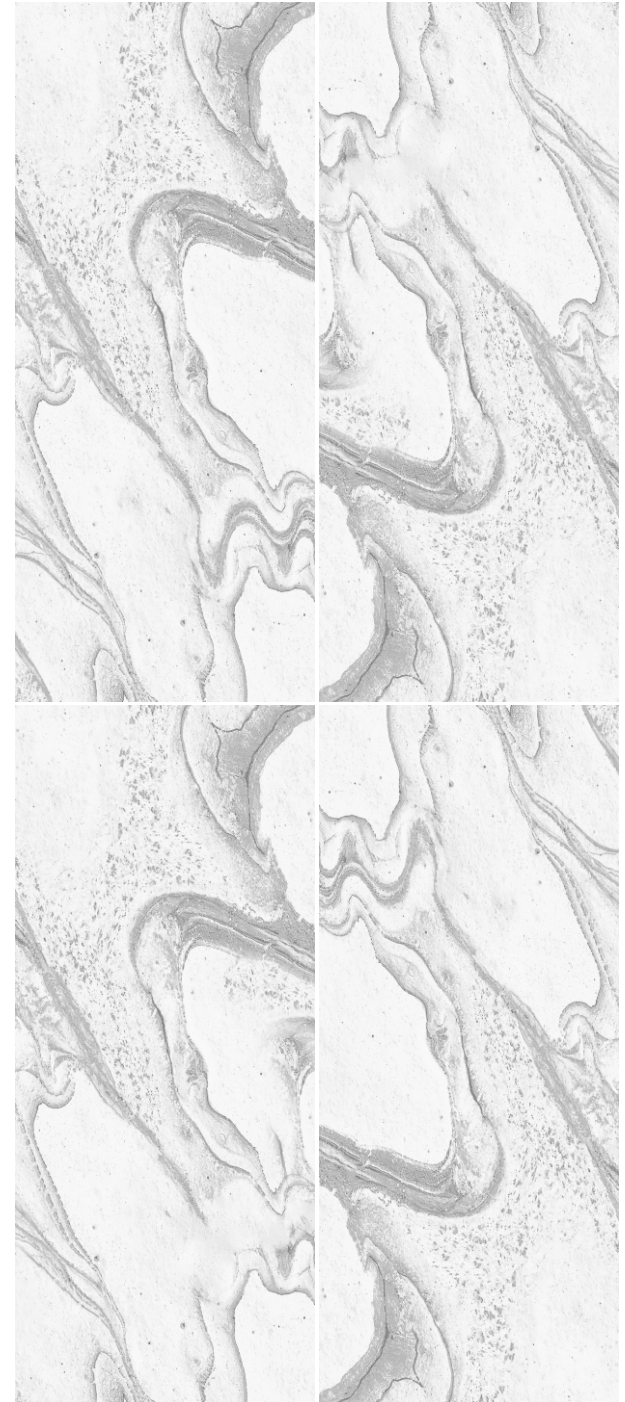

Random - 02
600x1200mm

Matt
Collection

Chicago Grey



Random - 01
600x1200mm

Matt
Collection

Chicago White



Random - 01
600x1200mm

Matt
Collection

Chicago Mist



Random - 01
600x1200mm

Matt
Collection

Chicago Pearl



Random - 01
600x1200mm

Matt
Collection



Chicago Mist | Pearl

Concord Blanco



Random - 01
600x1200mm

Matt
Collection

Concord Nero

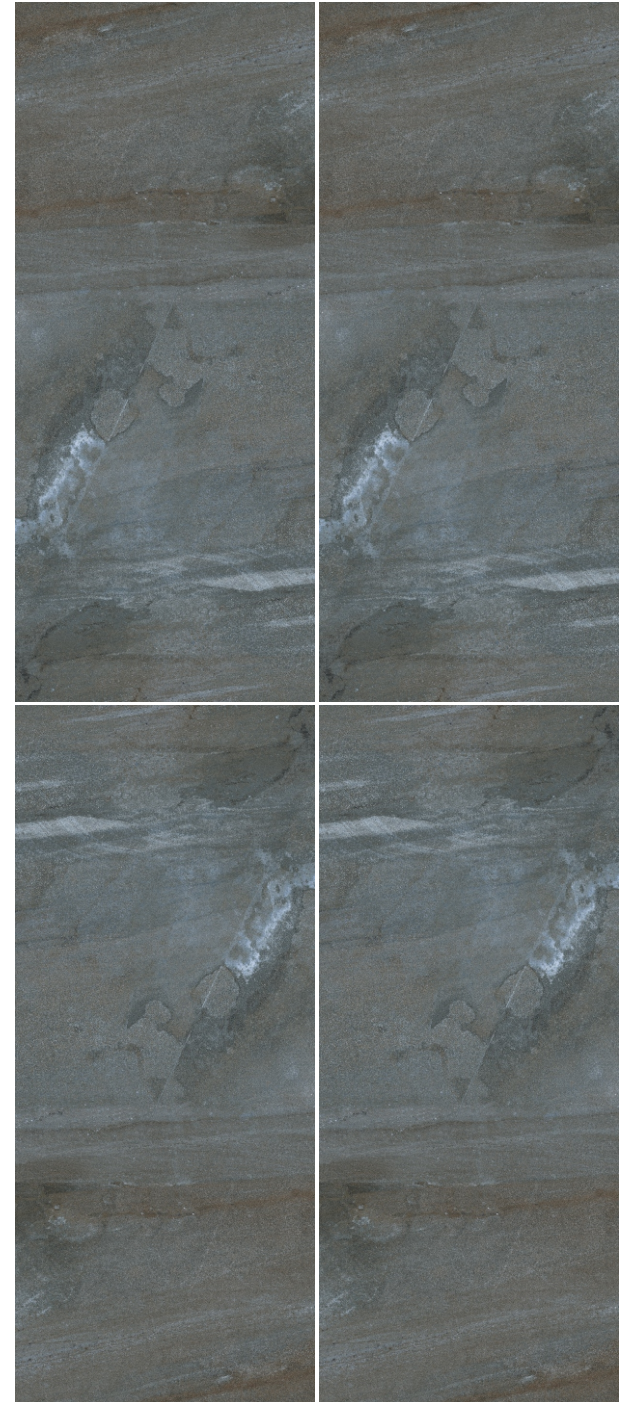

Random - 01
600x1200mm

Matt
Collection

Concord Crema



Random - 01
600x1200mm

Matt
Collection

Concord Mist



Random - 01
600x1200mm

Matt
Collection

Fabina Brown



Random - 01
600x1200mm



Matt
Collection

Fabina Ivory



Random - 01
600x1200mm



Matt
Collection

Fabina
Grey

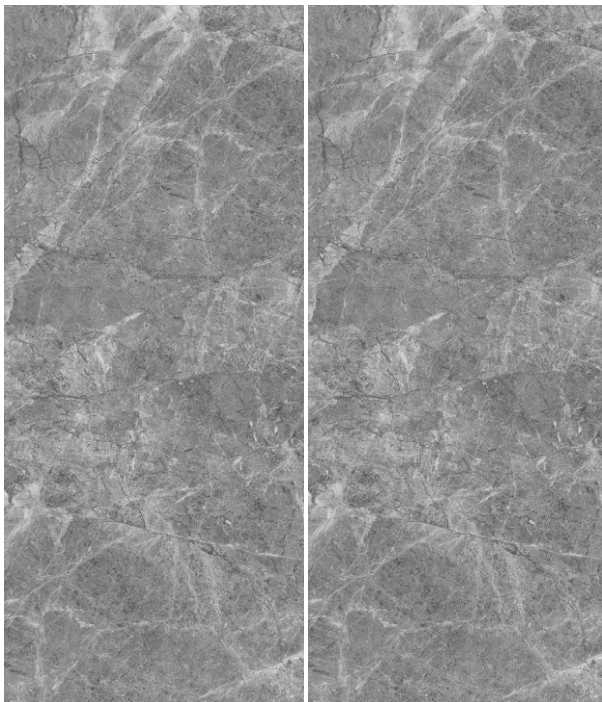

Random - 01
600x1200mm

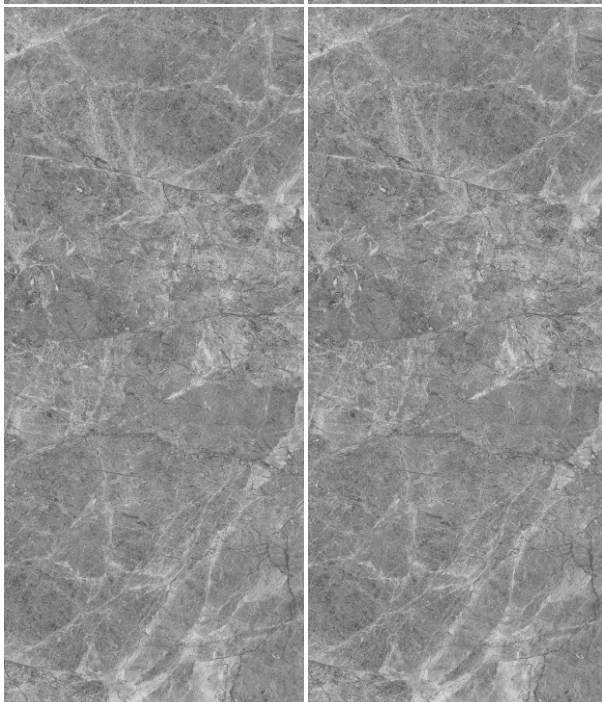

Matt
Collection

Fabina
White



Random - 01
600x1200mm



Matt
Collection

Hamilton Peral

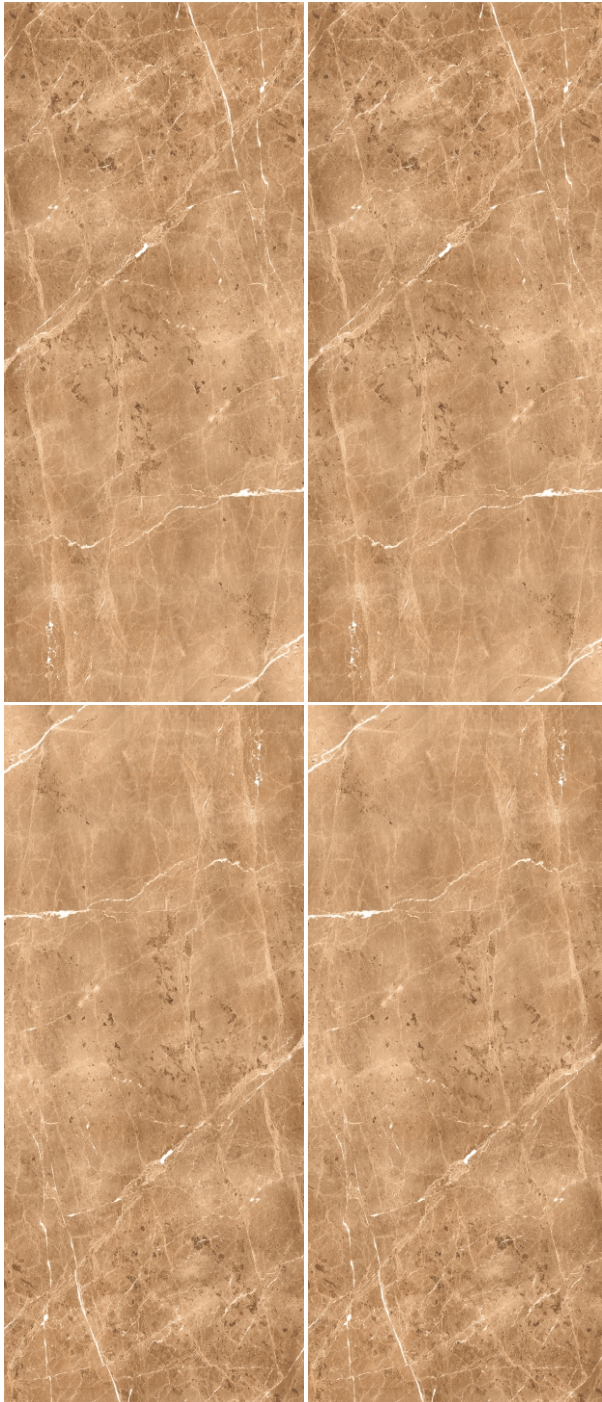

Random - 01
600x1200mm

Matt
Collection

Hamilton Crema



Random - 01
600x1200mm

Matt
Collection



Hamilton Peral | Crema

Hamilton Blanco



Random - 01
600x1200mm

Matt
Collection

Hamilton Grey



Random - 01
600x1200mm

Matt
Collection

Hamilton Brown

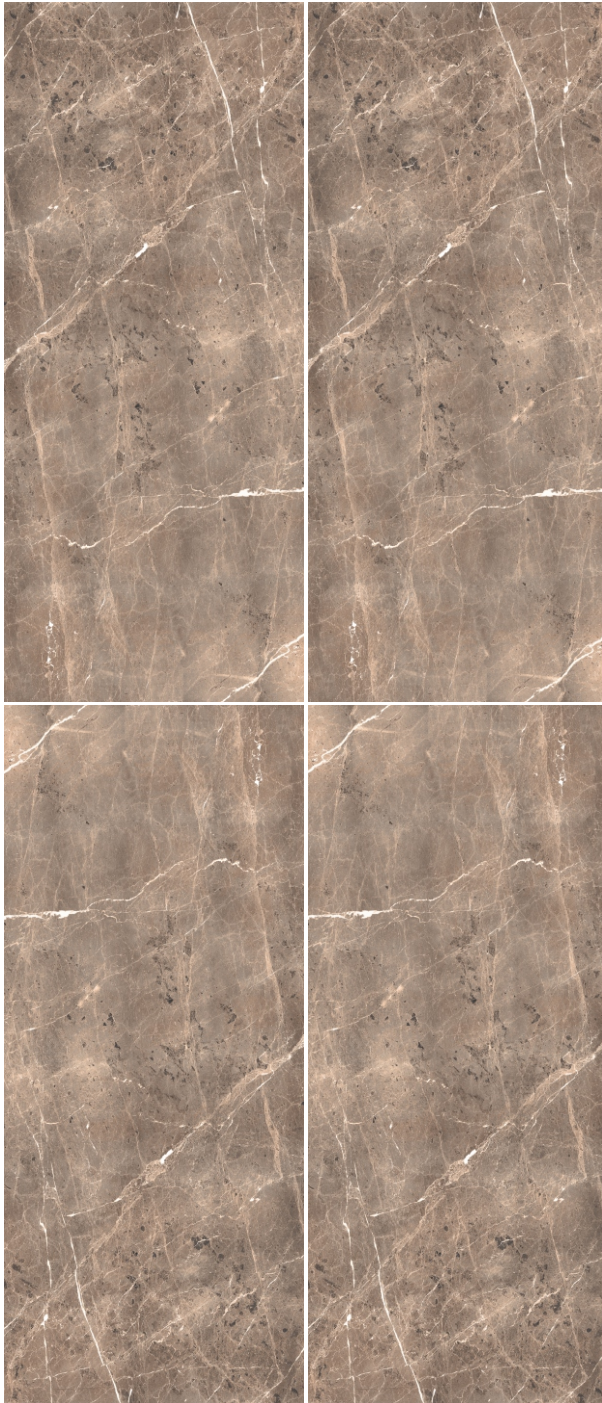

Random - 01
600x1200mm

Matt
Collection

Hamilton Nero

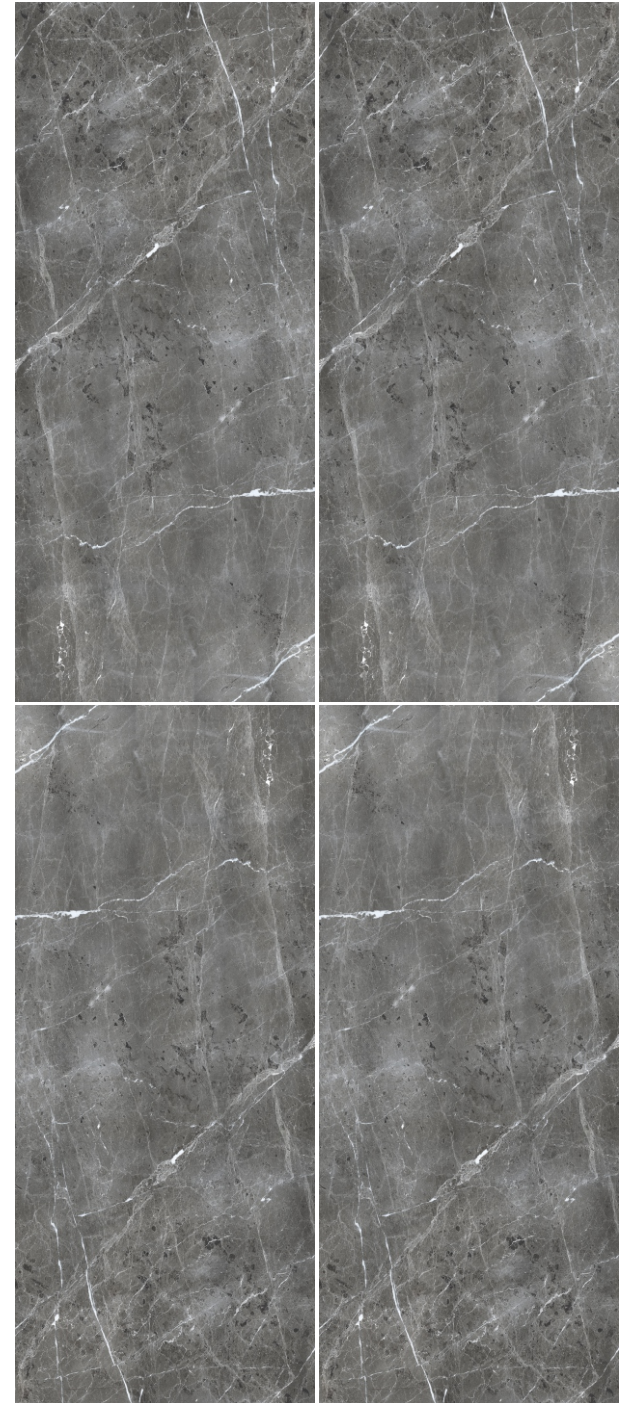

Random - 01
600x1200mm

Matt
Collection

Phantom Beige

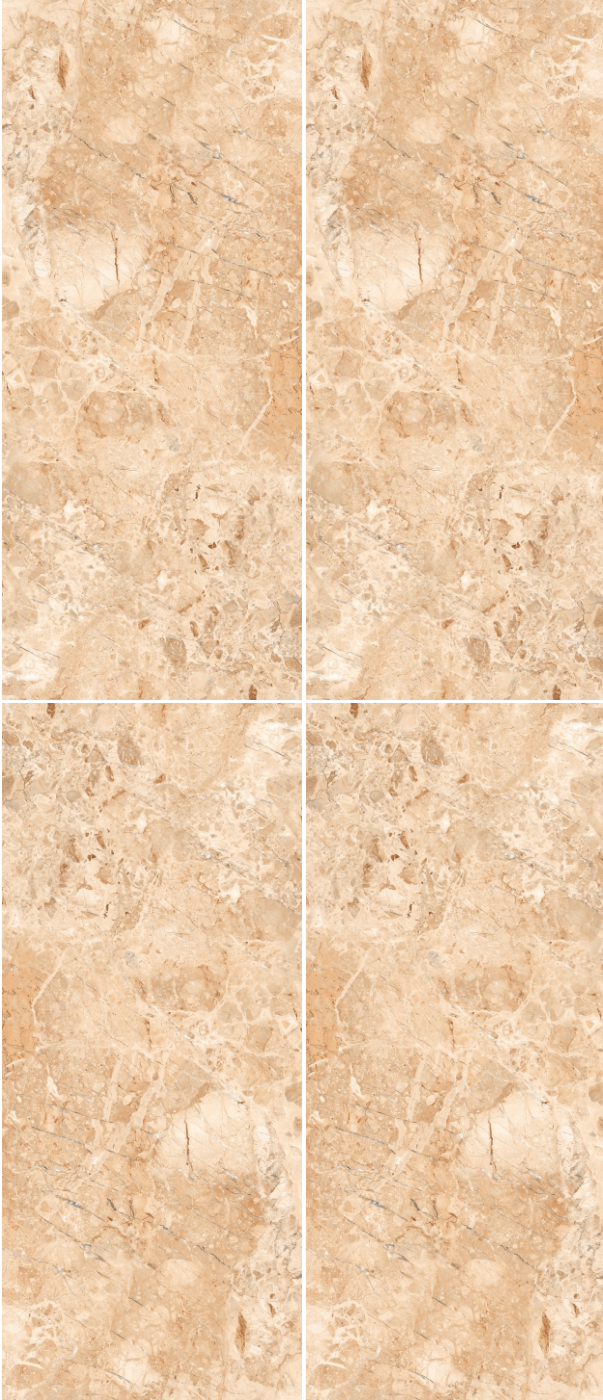

Random - 01
600x1200mm

Matt
Collection

Phantom Mist

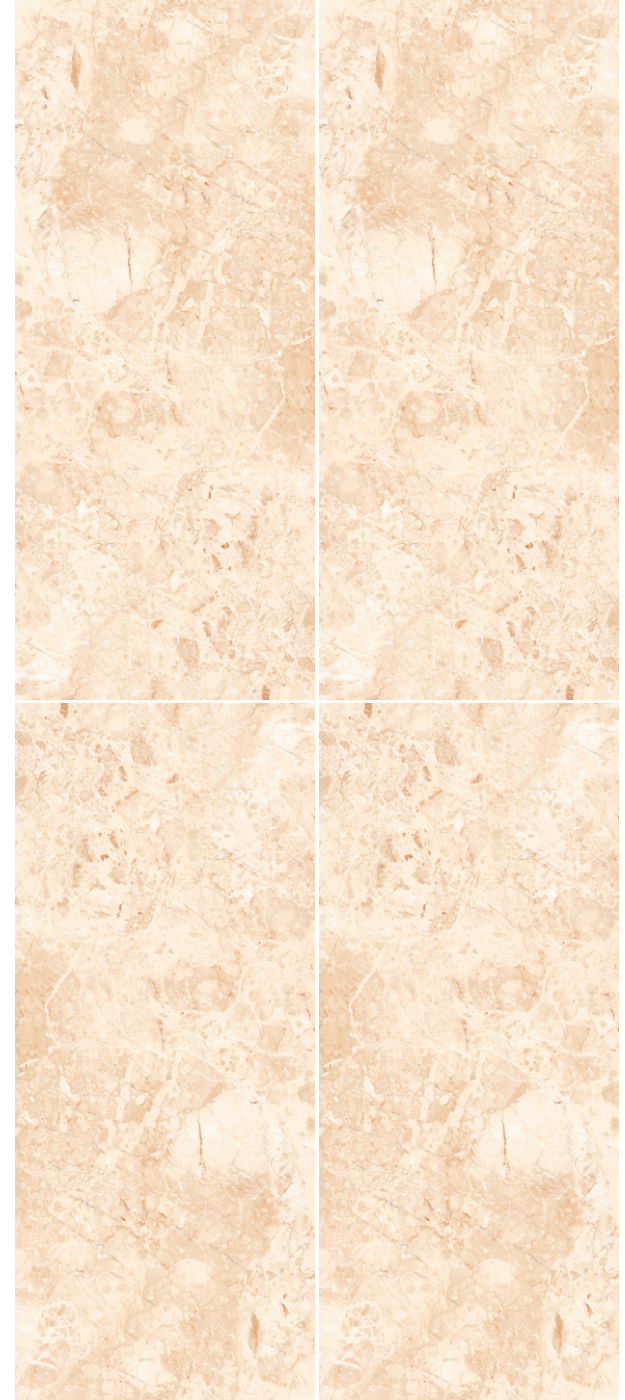

Random - 01
600x1200mm

Matt
Collection

Phantom Blanco



Random - 01
600x1200mm

Matt
Collection

Phantom Grey

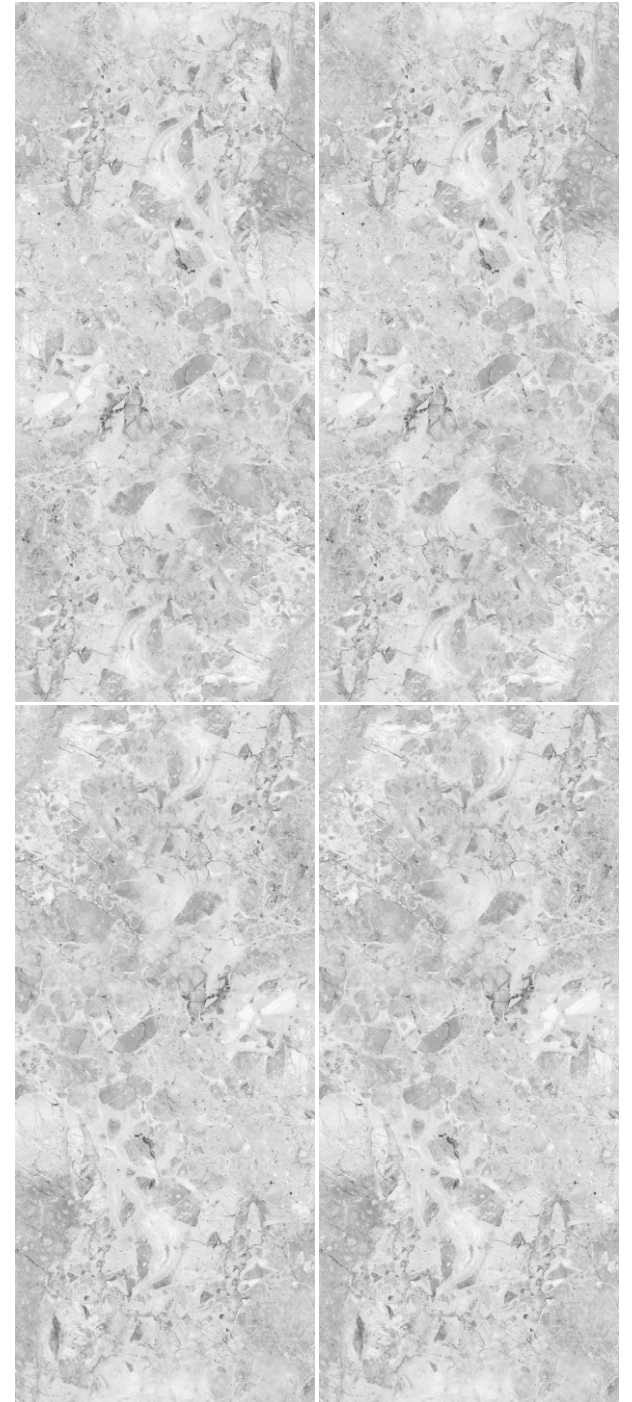

Random - 01
600x1200mm

Matt
Collection

Riverstone
Blanco



Random - **02**
600x1200mm

Matt
Collection

Riverstone
Grey



Random - **02**
600x1200mm

Matt
Collection



Riverstone Blanco

**Riverstone
Clay**



Random - 02
600x1200mm

Matt
Collection

**Riverstone
Pecan**

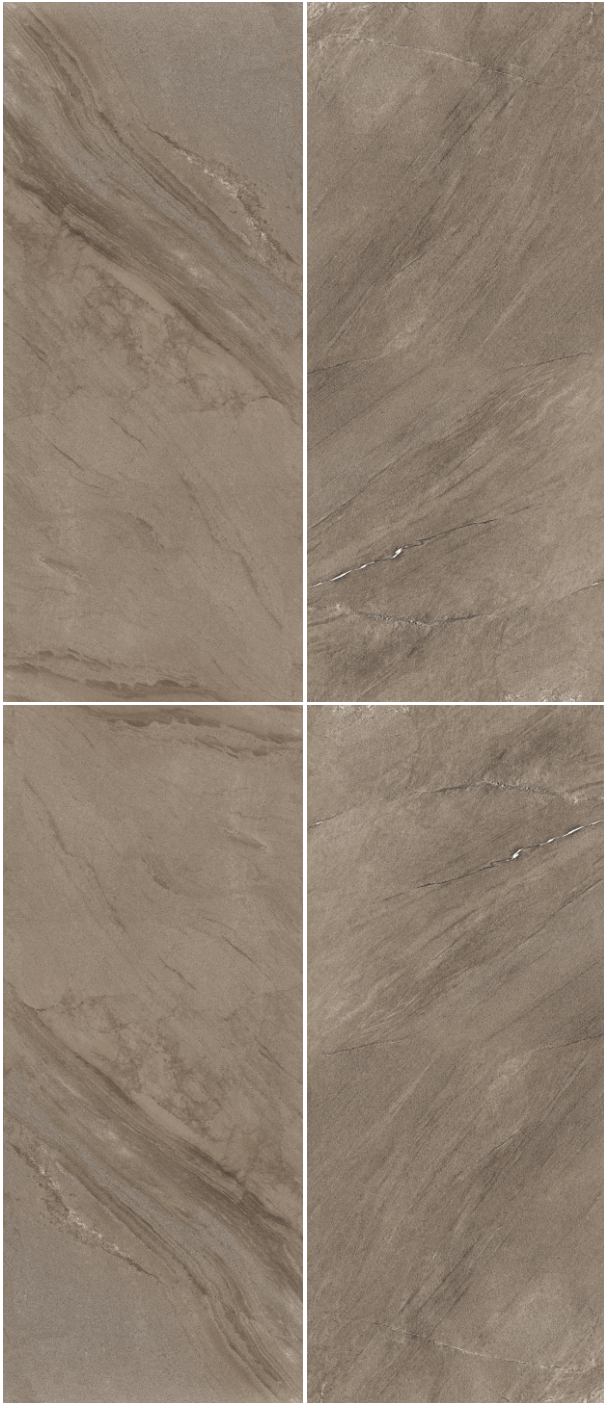

Random - 02
600x1200mm

Matt
Collection

Riverstone
Crema



Random - **02**
600x1200mm

Matt
Collection

Riverstone
Nero

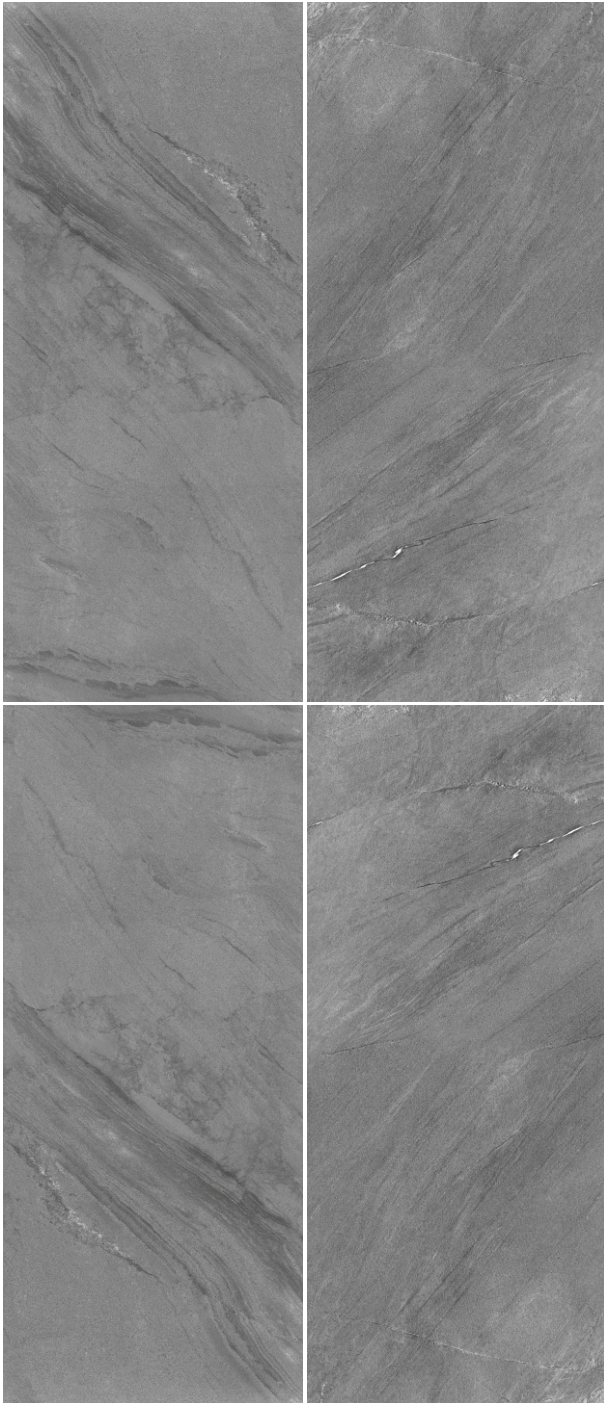

Random - **02**
600x1200mm

Matt
Collection

**Sandal
Wood
Teak**



Random - **02**
600x1200mm



Matt
Collection

**Sandal
Wood
Grey**



Random - **04**
600x1200mm



Matt
Collection

Capri White



Random - 01
600x1200mm

Matt
Collection

Lasa Carara



Random - 01
600x1200mm

Matt
Collection

**Cemento
Blanco**

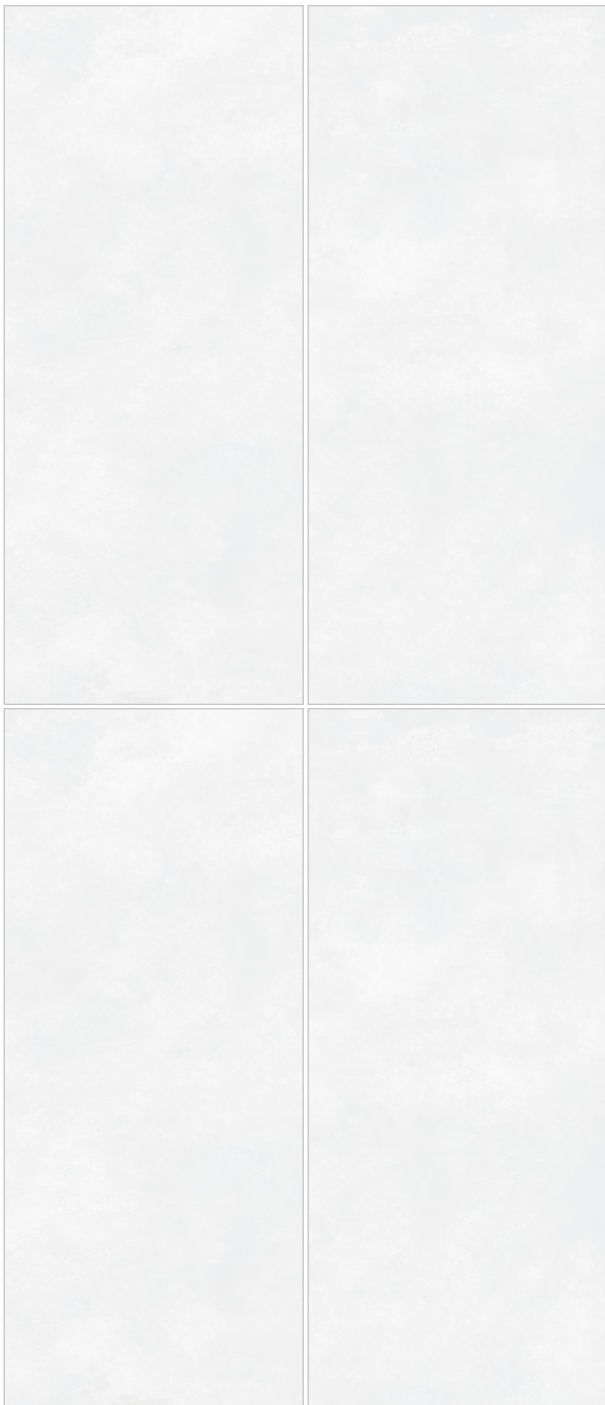

Random - **02**
600x1200mm

Matt
Collection

**Cemento
Grey**

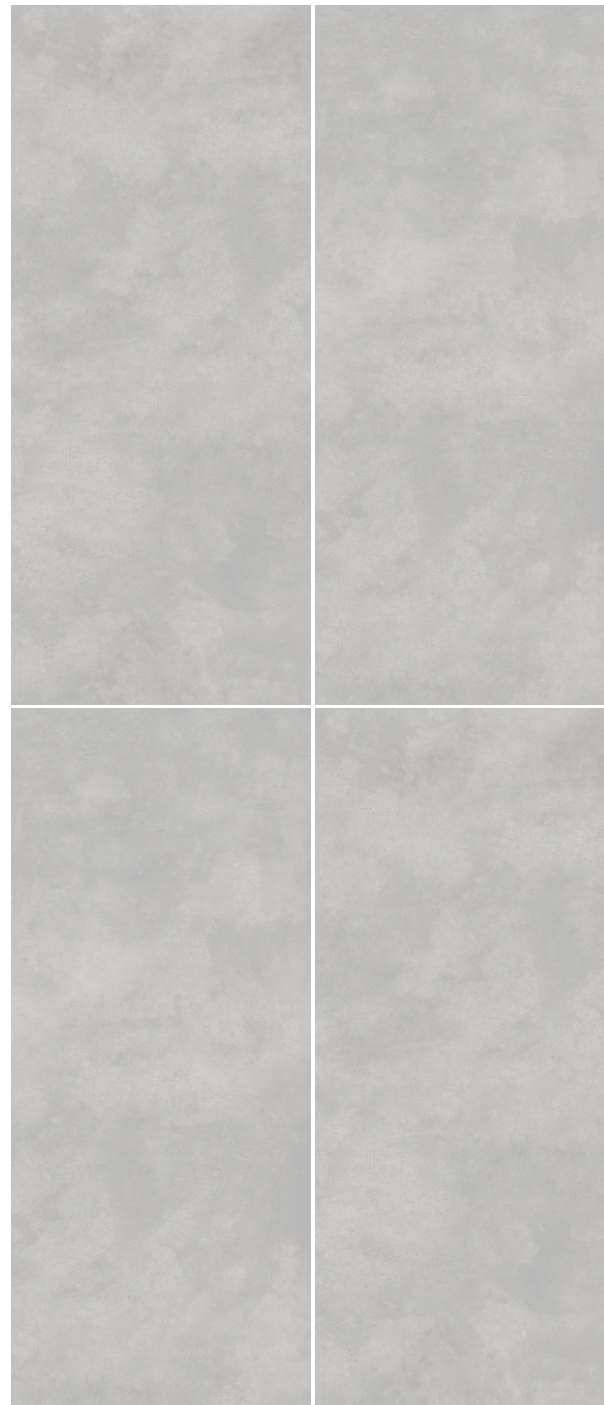

Random - **02**
600x1200mm

Matt
Collection



Cemento Grey

Cemento
Crema



Random - **02**
600x1200mm

Matt
Collection

Cemento
Cotto

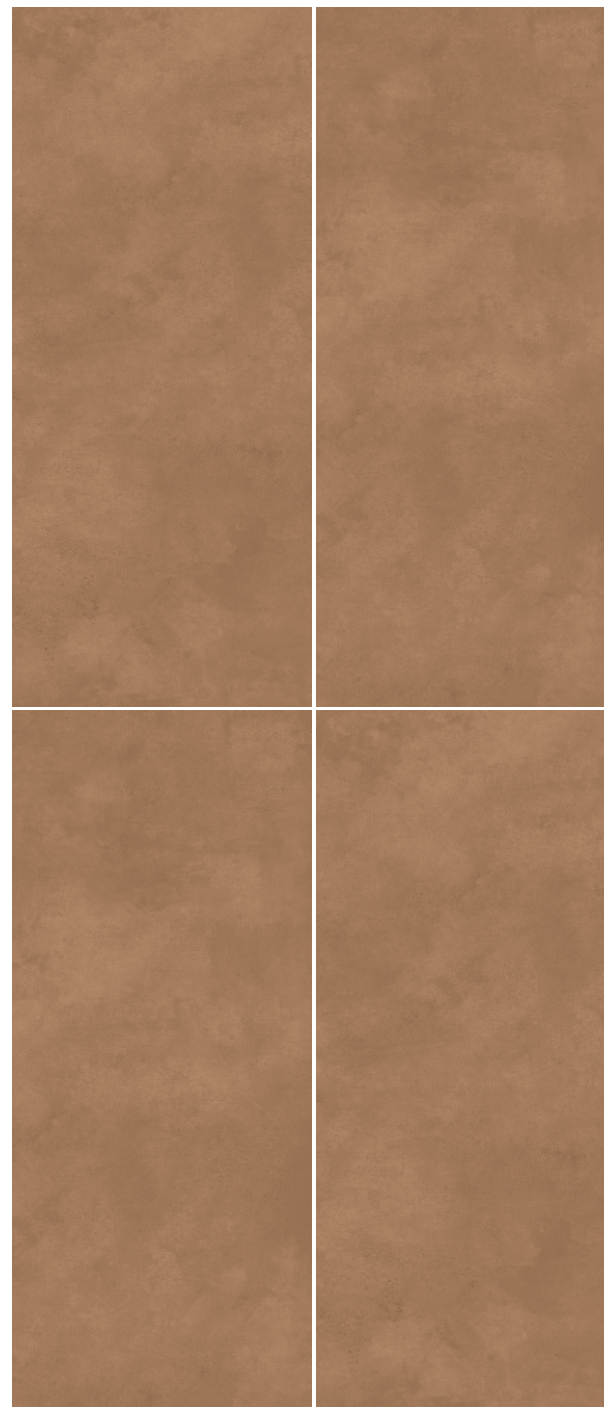

Random - **02**
600x1200mm

Matt
Collection

Cemento
Nero

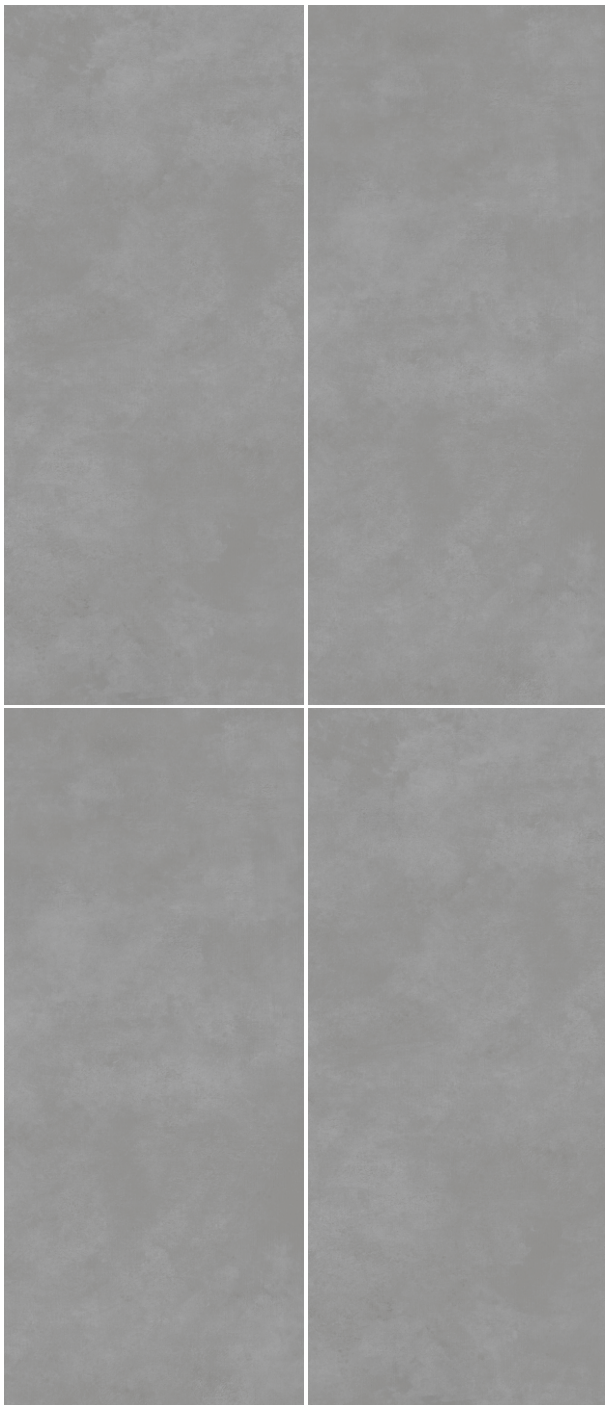

Random - **02**
600x1200mm

Matt
Collection

Cemento
Pecan



Random - **02**
600x1200mm

Matt
Collection

Marbella Blanco



Random - **04**
600x1200mm

Matt
Collection

Marbella Brown

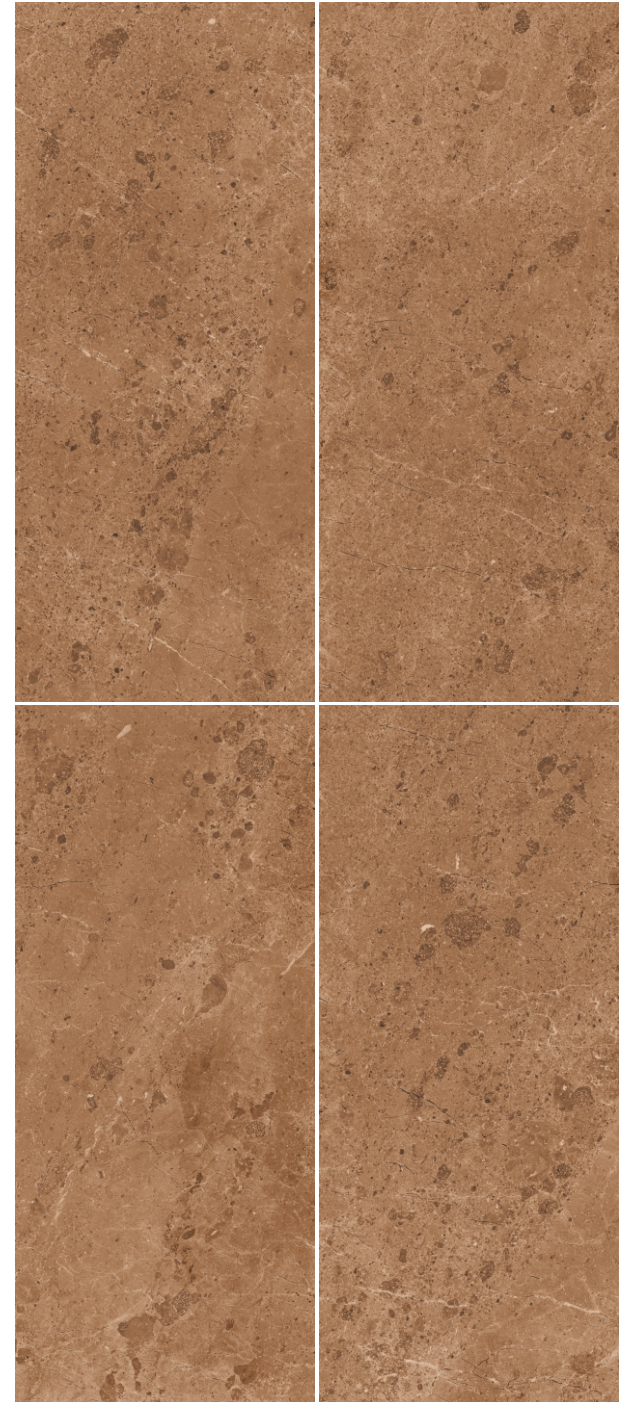

Random - **04**
600x1200mm

Matt
Collection

Monolith Silver



Random - **04**
600x1200mm



Matt
Collection

Monolith Blanco



Random - **04**
600x1200mm



Matt
Collection

Monolith Sand



Random - **04**
600x1200mm

Matt
Collection

Monolith Crema



Random - **04**
600x1200mm

Matt
Collection



Monolith Sand | Crema

Monolith Nero

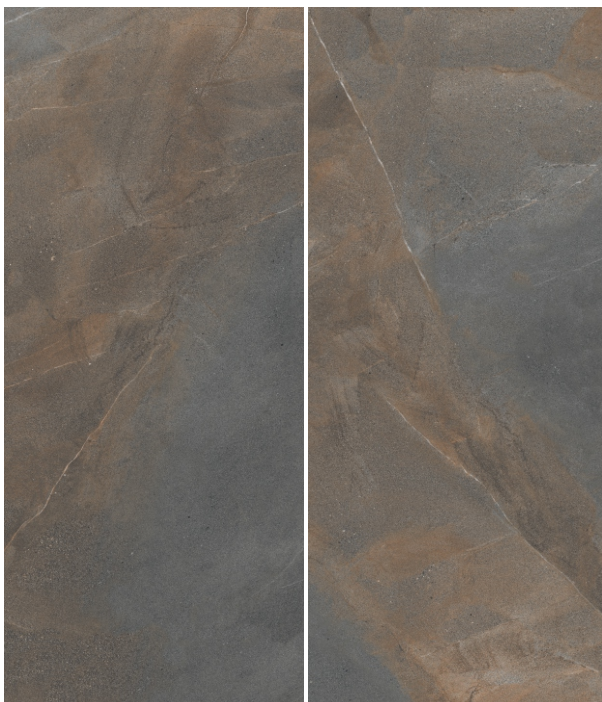

Random - **04**
600x1200mm

Matt
Collection

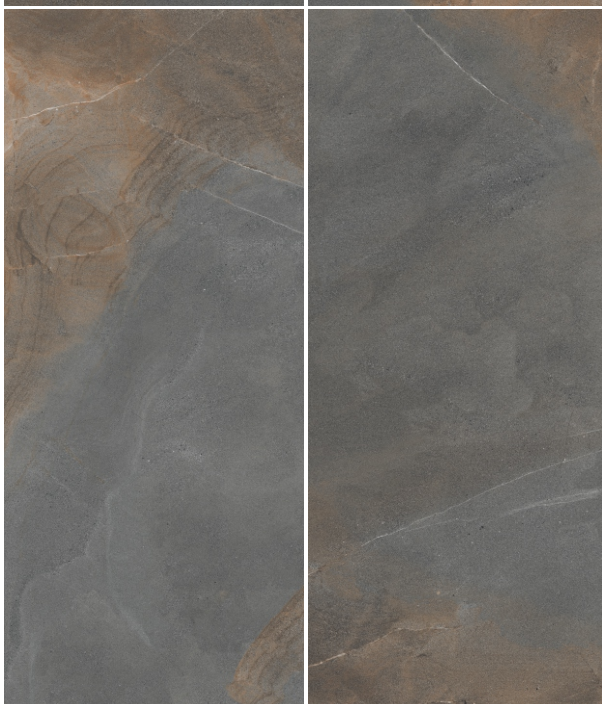

Monolith Bronze



Random - **04**
600x1200mm

Matt
Collection



Monolith Slate



Random - **04**
600x1200mm

Matt
Collection

Aras White



Random - **02**
600x1200mm

Matt
Collection

Sandal
Wood
Pine



Random - **04**
600x1200mm

Matt
Collection

Sandal
Wood
Teak



Random - **02**
600x1200mm

Matt
Collection

Timber
Wood
Pine



Random - **03**
600x1200mm

Matt
Collection

Timber
Wood
Walnut



Random - **03**
600x1200mm

Matt
Collection

Timber
Wood
Teak

Random - 03
600x1200mm

Matt
Collection



Velencia Blanco



Random - 01
600x1200mm

Matt
Collection

Velencia Grey



Random - 01
600x1200mm

Matt
Collection

Velencia Crema



Random - 01
600x1200mm

Matt
Collection

Velencia Mist



Random - 01
600x1200mm

Matt
Collection

**Axle
Wood
Teak**



Random - 03
600x1200mm

Matt
Collection



**Axle
Wood
Wenge**



Random - 03
600x1200mm

Matt
Collection



**Cherry
Wood
Grey**



Random - **03**
600x1200mm

Matt
Collection

**Cherry
Wood
Natural**

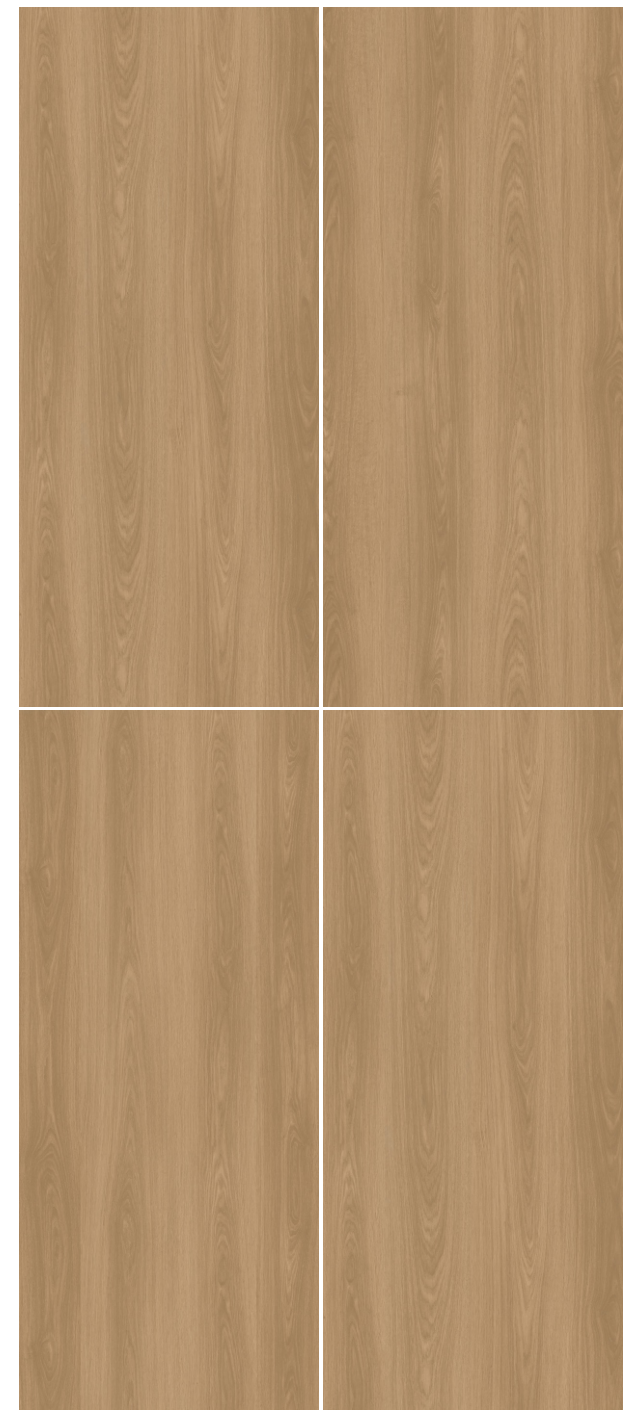

Random - **03**
600x1200mm

Matt
Collection

**Cherry
Wood
Pine**

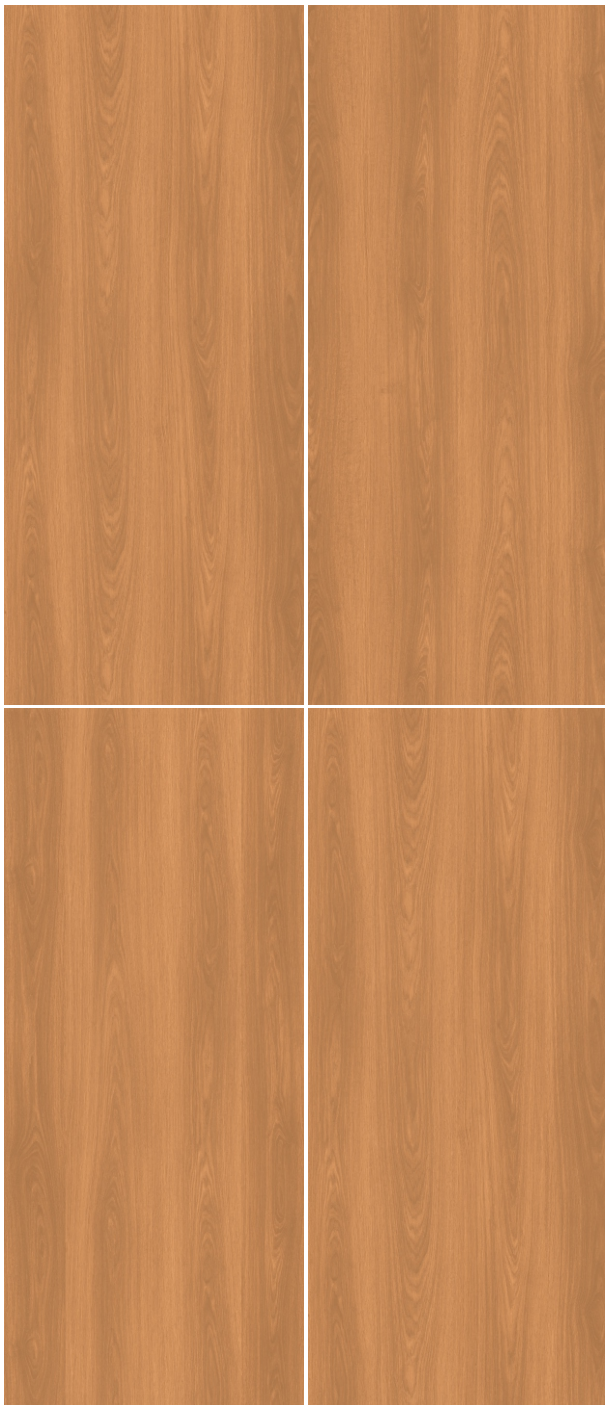

Random - **03**
600x1200mm

Matt
Collection

**Cherry
Wood
Teak**



Random - **03**
600x1200mm

Matt
Collection



Cherry Wood Pine

**Cheery
Wood
Walnut**

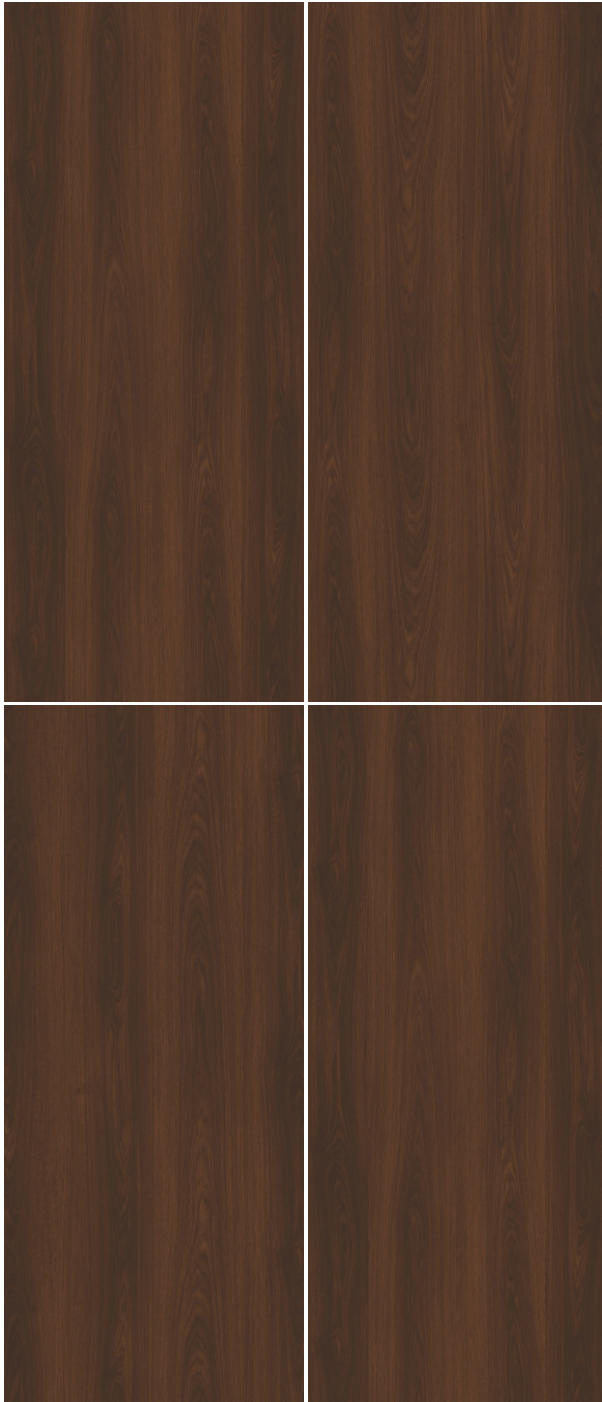

Random - 03
600x1200mm

Matt
Collection

**Cherry
Wood
Wenge**



Random - 03
600x1200mm

Matt
Collection

**Clara
Wood
Pine**



Random - **03**
600x1200mm

Matt
Collection



**Clara
Wood
Walnut**



Random - **03**
600x1200mm

Matt
Collection



**Clara
Wood
Wenge**



Random - **03**
600x1200mm



Matt
Collection

**Ekho
Wood
Grey**



Random - **05**
600x1200mm



Matt
Collection

**Ekho
Wood
Teak**



Random - 05
600x1200mm

Matt
Collection

**Ekho
Wood
Walnut**



Random - 05
600x1200mm

Matt
Collection

**Etro
Wood
Teak**



Random - **03**
600x1200mm

Matt
Collection

**Etro
Wood
Walnut**



Random - **03**
600x1200mm

Matt
Collection



Etro Wood Walnut

**Lyptus
Wood
Pine**



Random - 03
600x1200mm

Matt
Collection

**Lyptus
Wood
Teak**



Random - 03
600x1200mm

Matt
Collection



Lyptus Wood Teak

Technical Specifications.

CHARACTERISTIC	STANDARD AS PER ISO-13006/EN 14411 GROUP BIa	MEAN VALUE OF KERASTONE POLISHED GVT	MEAN VALUE OF KERASTONE GVT / PGVT	TEST METHOD
REGULATORY PROPERTIES				
Deviation in length & width	±0.5 %	±0.1 %	±0.1 %	ISO-10545-2
Deviation in thickness	±5.0 %	±4.0 %	±4.0 %	ISO-10545-2
Straightness in side	±0.5 %	±0.1 %	±0.1 %	ISO-10545-2
Rectangularity	±0.5 %	±0.1 %	±0.1 %	ISO-10545-2
Surface flatness	±0.5 %	±0.2 %	±0.2 %	ISO-10545-2
Color difference	Unaltered	No change	No change	ISO-10545-16
Glossiness	As per mfg	Min 90%	Min 4%	GLOSSOMETER
STRUCTURAL PROPERTIES				
Water absorption	< 0.50 %	< 0.20 %	< 0.20 %	ISO-10545-3
Apparent density	> 2.0 g/cc	>2.10 g/cc	>2.10 g/cc	DIN 51082
MASSIVE MECHANICAL PROPERTIES				
	Min. 35 N/mm	Min. 40 N/mm ²	Min. 40 N/mm ²	ISO-10545-4
Breaking strength	Min. 1300 N	Min. 2000 N	Min. 2000 N	ISO-10545-4
Impact resistance	As per mfg	Min. 0.55	Min. 0.55	ISO-10545-5
SURFACE MECHANICAL PROPERTIES				
Surface abrasion resistance	As per mfg	Min. Class-3	Min. Class-4	ISO-10545-7
MOH's hardness	As per mfg	Min. 4	Min. 5	EN 101
THERMO HYDROMETRIC PROPERTIES				
Frost resistance	No damage	No damage	No damage	ISO-10545-12
Thermal shock resistance	No damage	No damage	No damage	ISO-10545-9
Moisture expansion	Nil	Nil	Nil	ISO-10545-10
Thermal expansion (COE)	Max. 9.0 x 10 ⁻⁶	Max. 6.5x10 ⁻⁶	Max. 6.5 x 10 ⁻⁶	ISO-10545-8
Crazing resistance	As per mfg.	Min. 10 Cycle	Min. 10 Cycle	ISO-10545-11
CHEMICAL PROPERTIES				
Chemical resistance	No damage	No damage	No damage	ISO-10545-13
Stain resistance	Resistant	Resistant	Resistant	ISO-10545-14
SAFETY PROPERTIES				
Slip resistance	As per mfg.	>0.40	>0.40	ISO-10545-17
Fire resistance	As per mfg.	Fire proof	Fire proof	N. A.
Lead & Cadmium given o by glazed tiles	As per mfg.	Does not yield Pb & Cd	Does not yield Pb & Cd	ISO-10545-15

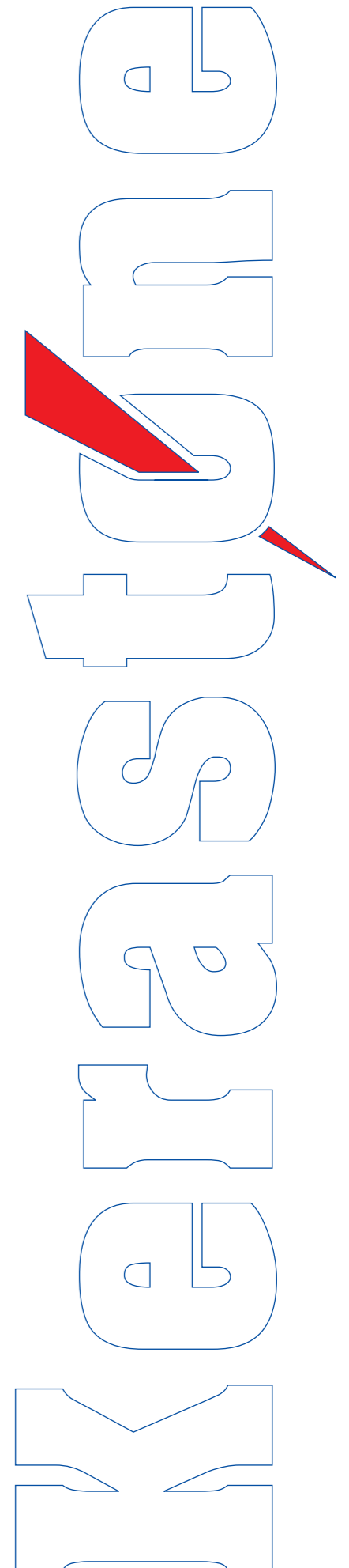

Packing Details.

SR. NO.	PRODUCT	NOMINAL SIZE	TILES PER BOX	COVERAGE AREA	WEIGHT
1	VITRIFIED TILES	600 x 1200 mm	2	1.44 Sq. Mtr.	29 Kg Approx..

Note: •Colour Shown are as accurate as the limitations of the printing process will allow. •Prospective customers are advised to inspect a sample of the tile before ordering. •Every effort has been made to ensure the accuracy of the information given. •However, the company reserve the right to change the specifications without prior notice. •Sometime variations in shade or size being inherent to ceramic industry may occur. •Before fixing, we advise you to follow the fixing instructions on the cartons of the tiles as no responsibility can be accepted by the company once the tiles have been fixed.

Applications.



DISCLAIMER : We reserves the right to delete & amend either totally of partially, and of the colours, shapes, size, references and other technical specification contain in catalogue at any time. the colours shown of tiles in this catalogue are purely illustrative and limited to printing process. Please refer actual sample final selection. The details of colours, size, references should be vitrified for Typographical errors. SHADE & SIZE VARIATIONS are inherent characteristics of ceramics. NO COMPLIANT SHALL BE SHALL ENTERTAINED ON TILES ALREADY LAID/FIXED.



SIDDHARTH
Since 28 Years

Manufactured By
JALARAM CERAMICS LIMITED

Manufacturing Unit

Block No. 184/185/186,
Village - Karoli, Near Khatraj Cross Road, Taluka : Kalol,
District : Gandhinagar, North Gujarat, India.
Tele : 02764 - 281511 / 281216 / 281217
Tele Fax : 02764 - 281029 / 281489
Mo. : +91 9824060914, 8758574802

Registered Head Office

511 - 512, Shiromani Complex,
Opposite Ocean Park, Near Nehrunagar Cross Road,
Satellite Road, Ahmedabad-380 015.
Tele : 079 - 26760652 / 26760685 Tele Fax : 079 - 26760614
Mo. : +91 9824600763 / +91 9924134488
Email : jclindia@yahoo.com / jalaramcera@gmail.com

Delhi Office :

Flat No. 210, 2nd Floor, Suneja Tower-1, District Centre,
Janakpuri, New Delhi-110 058. Mo. : +91 9312686655 / 9313993933

Mumbai Contact : Mo. : +91 9824060914 / +91 9512104141 / 8767741529 /

Bangalore Contact : Mo. : +91 9824060914 / +91 9620855115 / 9512104141

Kerala Contact : Mo. : +91 9824060914 / +91 9061004444 / 9512104141

Tamilnadu Contact : Mo. : +91 9824060914 / +91 9677241405 / 9512104141

Contact Person : Gujarat - +91 8758574802 / +91 9824060914
South Zone - +91 9512104141 / +91 9824060914 | Maharashtra / Goa
North East / M.P. / Rajasthan - +91 9512104141 / +91 9824060914

www.siddharthtiles.com